



[WWW.BSM DENTAL.COM](http://WWW.BSM DENTAL.COM)

**Aconia**<sup>®</sup>

INSTRUCTION MANUAL

**Chengdu Besmile Medical Technology Co., Ltd.**  
www.bsmdental.com  
T: +86-28-85317108  
E: info@cdbesmile.com

**Besmile Dental America Inc.**  
20311 Valley Blvd, Suite# I, Walnut, CA 91789  
T: (626)921-5798  
E: admin@bsmdentalus.com



  @Besmile  @besmile\_aconia

# Aconia Processing Guide



## Product Selection

Aconia Blanks.....01  
Indication Guide.....03  
Coloring Liquid.....05  
General Information...23



## CAD

Designing.....07



## CAM

Nesting.....09  
Milling.....10  
Aconia 3D Multilayer Technology...11



## Coloring

Fast Coloring Technique.....15  
Aesthetics Coloring Technique...17



## Sintering

Sintering Parameters...19



## Finishing

Grinding.....21  
Healing Treatment...22  
Sand Blasting.....22

# Product Selection

**Aconia** TT SHT ST HT+ Standard & Master Artist

**Multilayer**

**Preshade**

**White**

The grid displays the following product options:

- Multilayer:** Aconia TT-ML, Aconia SHT-ML, Aconia ST-ML.
- Preshade:** Aconia ST Preshade.
- White:** Aconia TT White, Aconia SHT White, Aconia ST White, Aconia HT White.

Additional images show bottles of Aconia Standard (A1) and Aconia Master (2M2) products.

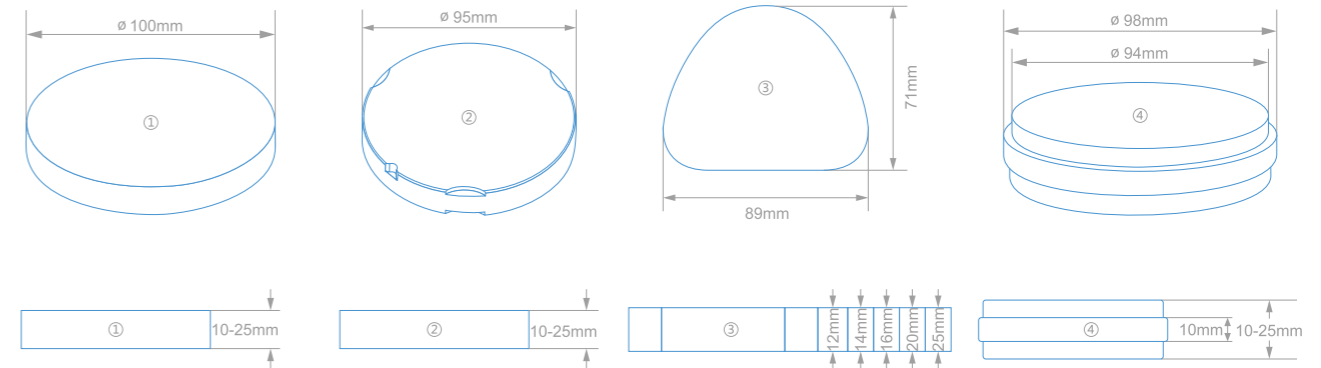

# Indication Guide

	Veneer	Inlay & Onlay	Reduced crown	Full contour crown	Coping	Full contour anterior bridge (3unit)	Full contour posterior bridge (3unit)	Full contour bridge (≤7unit)	Full contour bridge (≤14unit)	Abutment
<b>TT</b> (3D Multilayer & White)										
<b>HOT</b> <b>SHT-ML</b> (3D Multilayer)										
<b>SHT</b> (White)										
<b>UPGRADED</b> <b>ST</b> (3D Multilayer & Preshade & White)										
<b>HT+</b> (White)										

Ideal results depend on the individual circumstance.



## Standard & Master



Applied to Aconia® white ,  
TT, SHT ,ST , HT+, specifically.

50ml

### Standard

- Precisely match to VITA\* 16 shade guide
- Dipping & Brushing
- Time saving & Pontic lighting
- Ideal results applied on Aconia white blanks by Aconia Coloring Technology

The terms marked with \* are registered trademarks and/or brand names of the respective companies.

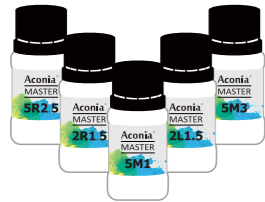

Applied to Aconia® white ,  
SHT ,ST , HT+, specifically.

50ml

### Master

- Precisely matches VITA\* 26 color system
- Dipping & Brushing
- Time saving & Pontic lighting
- Ideal results applied on Aconia white blanks by Aconia Coloring Technology

The terms marked with \* are registered trademarks and/or brand names of the respective companies.



## Artist



20ml

### Artist

- Art effect creation
- No need to mix – just start
- Individual customization
- Ideal results applied on Aconia blanks



### Special colors

#### Magic value



#### Natural gingival



#### Incisal translucency



#### Art fissure



## Designing

### Please follow the instructions below:

- To avoid stress concentration, pay attention to path of insertion, undercut, the distance between occlusal and gingival, clearly visible gingival margin.
- Ensure
  - minimum **0.8** mm of labial wall thickness.
  - minimum **1.0** mm of lingual wall thickness.
- Length of continuous pontics under **30** mm  
Length of continuous cantilevers under **15** mm
- Anterior connector cross section area **9** mm<sup>2</sup>  
Posterior connector cross section area **12** mm<sup>2</sup>

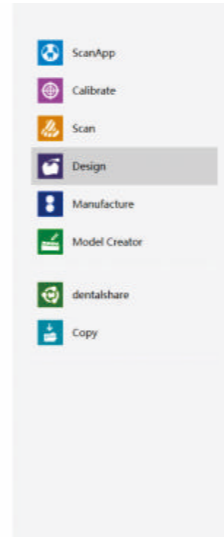
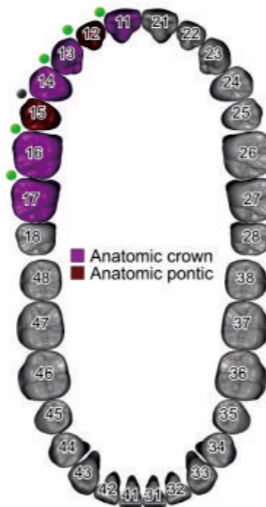
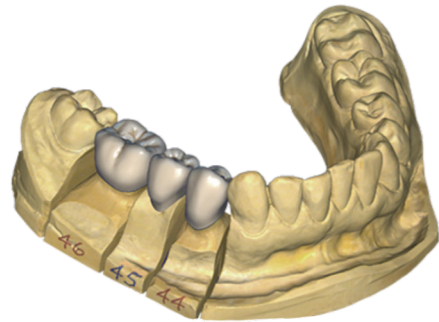

## TIPS ON TEETH PREPERATION

### A. Anterior

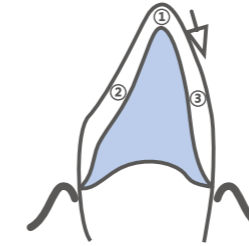

- Incisal reduction  $\geq 2.0$  mm
- Lingual wall thickness  $\geq 1.0$  mm
- Labial wall thickness  $\geq 0.8$  mm
- Outline :  
Nature-like Lingual outline  
Convergence angle 3° to 5°

### B. Posterior

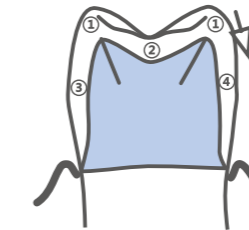

- Occlusal thickness  $\geq 1.3$  mm
- Occlusal opening angle 120° to 140° with rounded edges
- Lingual wall thickness  $\geq 1.0$  mm
- Labial wall thickness  $\geq 0.8$  mm
- Convergence angle 6° to 8°

### C. Shoulder & Margin

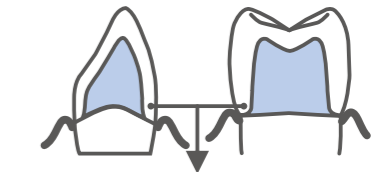

- Cervical margin  $\geq 1$  mm  
90° shoulder with rounded edge

Please follow the instruction of the CAM software

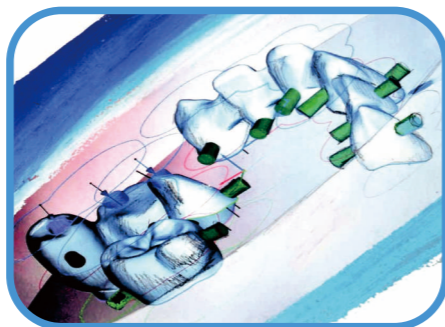

### A. Connector

- ① Set the Connectors on Labial and Lingual sides
- ② Set the connectors on the height of contour between middle 1/3 with cervical 1/3 of the restoration
- ③ No Connectors on the pontic
- ④ No Connectors on the adjacent area

### B. Sintering frames

Sintering frames is recommended for the bridge & crowns  
With more than 7 units

### Loading on the holder

- A. Make sure the holder is clean without any dust before loading
- B. Put the zirconia blank into the holder with the surface horizontal
- C. Gradually tighten the screw in the order 1-2-3-4
- D. Please adjust the position of markers in blank prior to loading, and try to keep the same position each time.

Different Brand/type of milling machines have different procedures in loading, please refer to manufacturer's instructions strictly.



### De-Spruing

- A. Professional tool under 10,000-12,000 r/min
- B. Order
  - ① Position crowns and bridges on their occlusal surfaces
  - ② Start from the connectors on the margin
  - ③ End with the connectors on mesial and distal surface  
a. — b — c1 — c2
- C. Reduction less than 0.5mm every time
- D. For bridge & Crowns, cut down the connectors outside only
- E. Clean the shaped restoration by brush or air gun.

### Inspection

Cracks or fractures  
Faulty restorations must not be processed further.



# Aconia 3D Multilayer Technology

Simply mill, sinter and glaze!

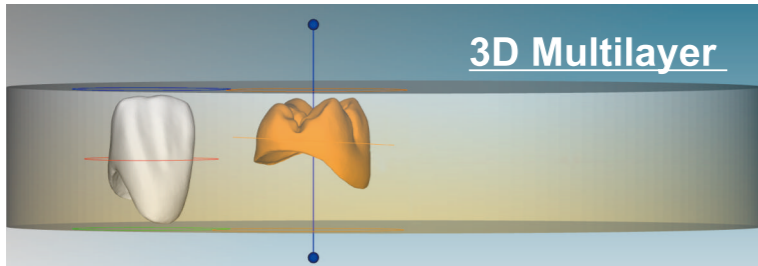

1. Gradient chroma:  
Increasing chroma from the top to bottom
2. Gradient translucency:  
Increasing translucency from bottom to top
3. Gradient flexural strength:  
Increasing flexural strength from top to bottom

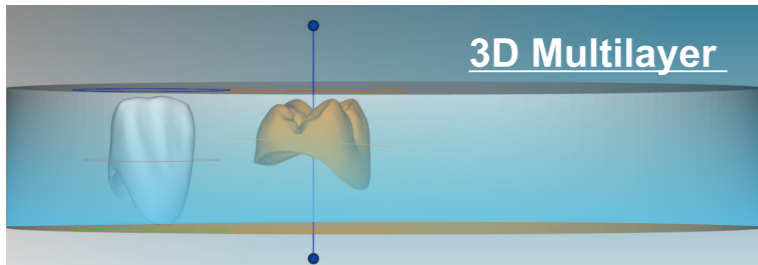

Gradient translucency  
From bottom to top

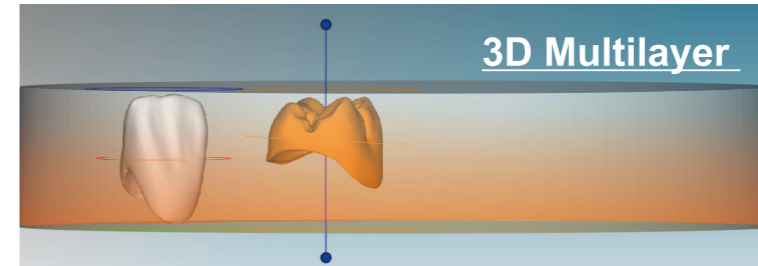

Gradient chroma  
From the top to bottom

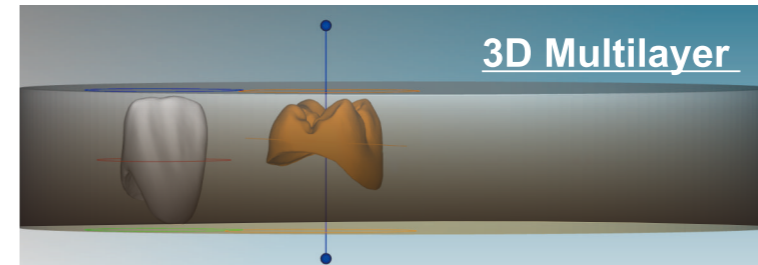

Gradient flexural strength  
Decrease the tooth wear coefficient

# Aconia 3D Multilayer Technology

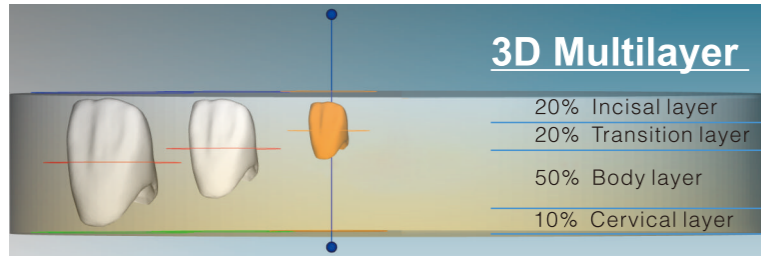

## 3D Multilayer

### Layer heights:

	14mm	16mm	18mm	20mm	22mm
20% Incisal layer	2.8 mm	3.2mm	3.6 mm	4 mm	4.4 mm
20% Transition layer	2.8 mm	3.2mm	3.6 mm	4 mm	4.4 mm
50% Body layer	7 mm	8mm	9 mm	10 mm	11 mm
10% Cervical layer	1.4 mm	1.6mm	1.8 mm	2.0 mm	2.2 mm

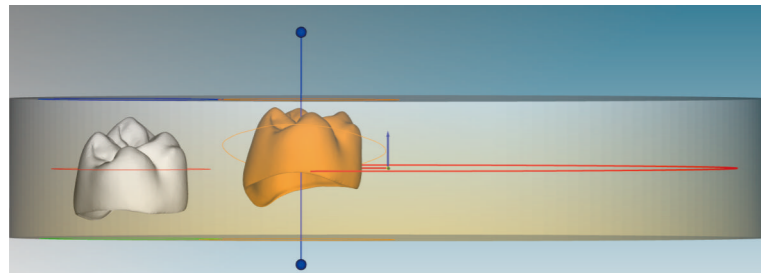

Upper the position  
Higher translucency for the incisal/cusps  
Occlusal surface parallel to the blank surface

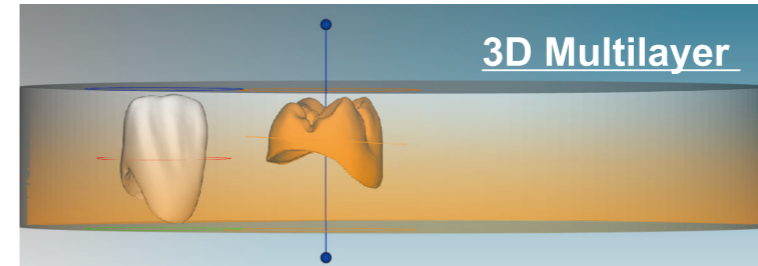

## 3D Multilayer



Increased body layer - 50%  
Maximized flexibility of the height usage

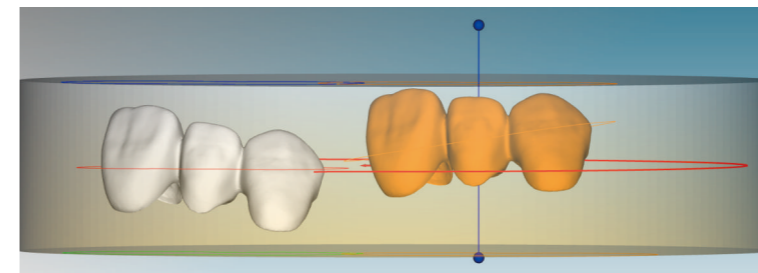

Upper the position  
Higher translucency for the incisal/cusps  
Adjust the bridge in the blank to get the ideal result.

# Fast Coloring Technique

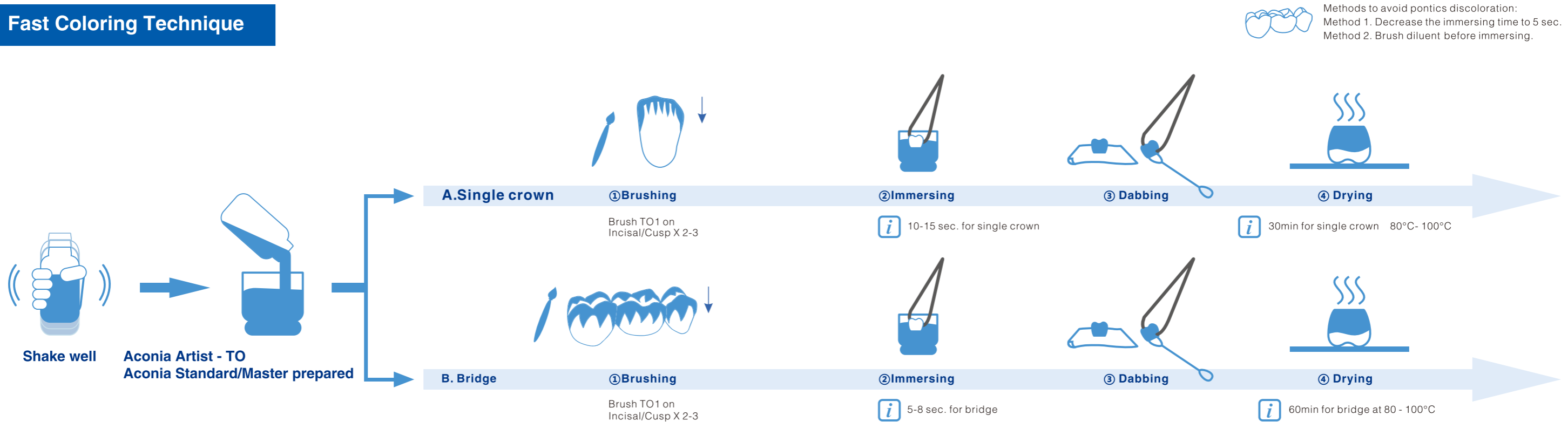

Immersing time can be modified according to the wall thickness of the restorations.

# Aesthetics Coloring Technique



Shake well



Aconia Artist  
Aconia Standard/Master prepared



① Brush TO1

On Incisal/Cusp X 2-3



② Brush TO2/TO3

**i** 10-15 sec. for single crown  
5-8 sec. for bridge



③ Immersing



④ Dabbing



⑤ Drying

**i** 10min at 80 - 100°C



⑥ Brush O1&O2 & Special colors



⑦ Drying

**i** 30min for single crown  
60min for bridge at 80 - 100°C



The coloring skills will be enhanced with the experience accumulation of dental technicians.



# Sintering

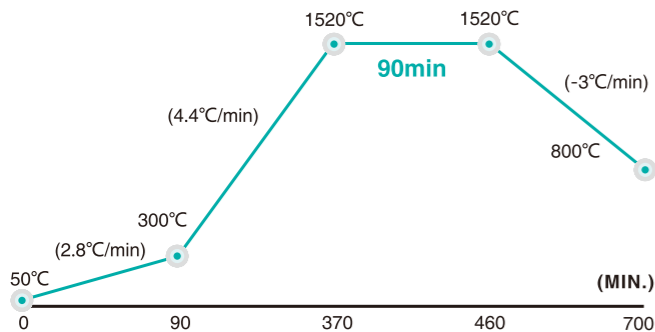
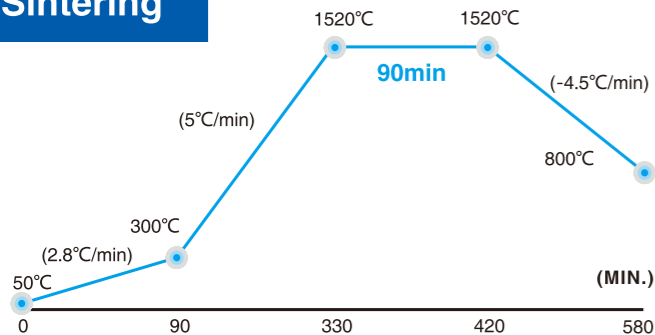

## Aconia® Sintering Parameters(1-7units)

Applied to **ST/SHT/TT**(Multilayer), **ST**(Preshade), **HT+/ST/SHT**(White)

Step	Initial Temp.	Rate	Final Temp.	Time
1	50°C	2.8°C/min	300°C	90min
2	300°C	5°C/min	1520°C	240min
3	1520°C	Holding	1520°C	90min
4	1520°C	- 4.5°C/min	800°C	160min
5	800	Natural cooling		

\*Applied to single unit and bridges under 7 units(>7units)

\*It's recommended to use BSM-S30 sintering furnace.Input "-121" to enter into the natural cooling process.

## Aconia Bridge Sintering Parameters(> 7 units)

Applied to **ST/SHT**(Multilayer), **ST**(Preshade), **HT+/ST/SHT**(White)

Step	Initial Temp.	Rate	Final Temp.	Time
1	50°C	2.8°C/min	300°C	90min
2	300°C	4.5°C/min	1520°C	280min
3	1520°C	Holding	1520°C	90min
4	1520°C	- 3°C/min	800°C	240min
5	800	Natural cooling		

\*Applied to bridges above 7 units(>7units)

\*It's recommended to use BSM-S30 sintering furnace.Input "-121" to enter into the natural cooling process.

\*For the full-arch restorations/ thick-crown restorations etc., it's suggested to extend the holding time to 120min.

\*Long span bridges should be sintered with sintering frame

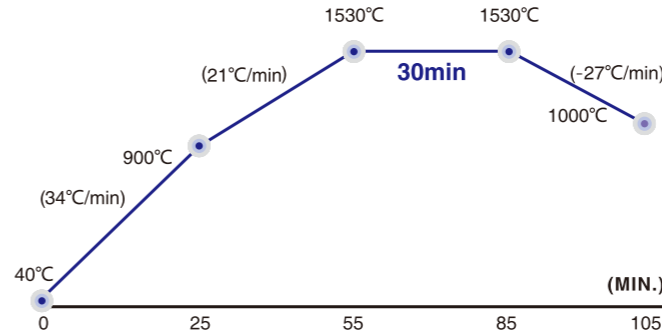
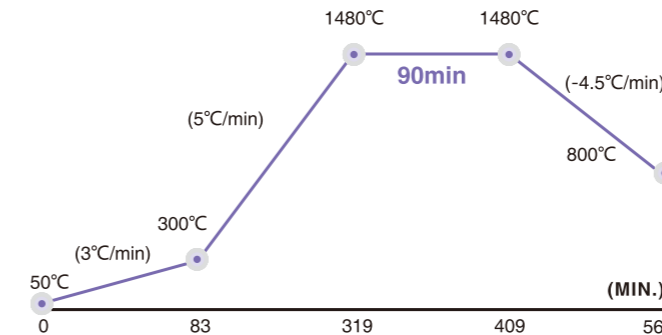

## Aconia® TT (White) Standard Sintering Parameters

Applied to single unit and bridges under 3 units(1-3units)

Step	Initial Temp.	Rate	Final Temp.	Time
1	50°C	3°C/min	300°C	83min
2	300°C	5°C/min	1480°C	236min
3	1480°C	Holding	1480°C	90min
4	1480°C	- 4.5°C/min	800°C	151min
5	800	Natural cooling		

\*It's recommended to use BSM-S30 sintering furnace.Input "-121" to enter into the natural cooling process.

## Aconia® Fast Sintering Parameters(1-3 units)

Applied to **ST/SHT/TT**(Multilayer),**ST**(Preshade), **HT+**(White)

Step	Initial Temp.	Rate	Final Temp.	Time
1	40°C	34°C/min	900°C	25min
2	900°C	21°C/min	1530°C	30min
3	1530°C	Holding	1530°C	30min
4	1530°C	- 27°C/min	1000°C	20min
5	1000°C	Natural cooling		

\*Applied to single unit and bridges under 3 units(1-3 units)

\*It's recommended to use BSM-FC30 sintering furnace.Input "-20" to enter into natural cooling process.



19

A. Sintering can take place in all common dental sintering furnaces which are approved for the sintering of restorations made of zirconium dioxide.

B. It has been proved that above curves lead to the best outcome of Aconia®, and sintering programs also can be adjusted according to the specific situations, and different furnaces.

C. Please clean the furnace regularly.





**Grinding is not recommended after sintering, if it is inevitable, please follow the tips as below:**

① Professional dental zirconia grinding instrument

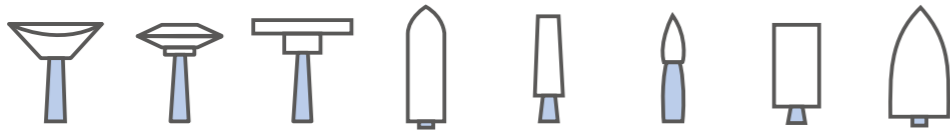

② Cooling is crucial during polishing

③ Grinding with a light pressure by a single direction

④ Grinding speed 20,000-25,000 r/m

⑤ No grinding inside the crown

## Heating treatment

Recommend to increase the strength and blinding force to zirconium porcelain

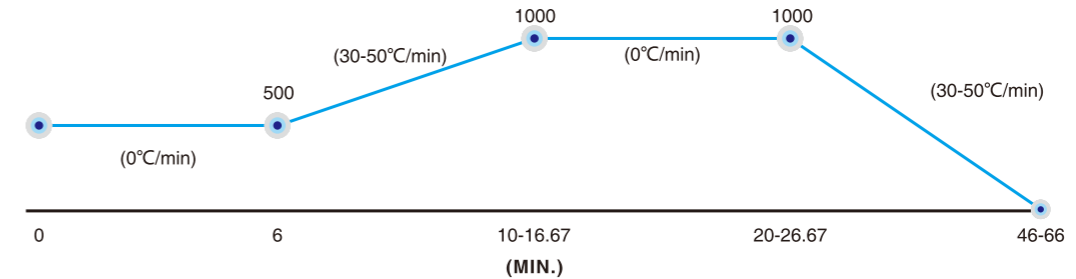

## Sand blasting

Sand blasting is recommended for cleaning, recovering material strength as well as a better connection with veneering material.

1. Before sand blasting, cleaning is necessary with ultrasound in a water bath or a steam jet.
2. High purity alumina sand —50 μ m(270 mesh)
3. Under the pressure of 2-2.5Bar(0.2-0.25mpa)

For veneering the restoration, staining and glazing , as well as cut-back and layering techniques,

or a combination of both, are suitable for **Aconia**

Please follow the instruction for use of the manufacturer.

## Technical Data

	TT-ML	SHT-ML	ST-ML	TT	ST (Preshade)	HT <sup>+</sup>
<b>Translucency</b>	43%-49%	43%-46%	42%-45%	49%	43%	42%
<b>Flexural strength/Mpa</b>	600-900	900-1100	1000-1200	800±100	1250±100	1400±100
<b>Density/(g/cm<sup>3</sup>)</b>	>3	>3	>3	>3	>3	>3
<b>Sintered Density/(g/cm<sup>3</sup>)</b>	>6.02	>6.02	>6.02	>6.02	>6.02	>6.02
<b>Fracture toughness/(Mpa.m<sup>1/2</sup>)</b>	>3	>5	>5.5	>3	>5.5	>9
<b>Vickers-hardness HV10</b>	1300±5%	1300±5%	1300±50	1300±5%	1300±5%	1300±5%
<b>CTE</b>	(10.5±0.5)* 10 <sup>-6</sup> K <sup>-1</sup>	(10.5±0.5)* 10 <sup>-6</sup> K <sup>-1</sup>	(10.5±0.5)* 10 <sup>-6</sup> K <sup>-1</sup>	(10.5±0.5)* 10 <sup>-6</sup> K <sup>-1</sup>	(10.5±0.5)* 10 <sup>-6</sup> K <sup>-1</sup>	(10.5±0.5)* 10 <sup>-6</sup> K <sup>-1</sup>
<b>Radioactivity/Bq.g<sup>-1</sup></b>	<0.1	<0.1	<0.1	<0.1	<0.1	<0.1
<b>Chemical solubility/(μg/cm<sup>2</sup>)</b>	<50	<50	<50	<50	<50	<50







## Storage & Handling

Please check the package and product carefully before using. Operated only by professionals.  
Transportation avoid damage from collision, extrusion and vibration.  
Storage: The product must be stored in its original packaging at room temperature.  
Expiry date: Long-term.

### Warning

Operator must wear dust mask.  
Do not get dust into eyes or directly contact with skin.

### Symbol:

	Date of Production		Expiry date	<b>LOT</b>	Batch number
	Caution		Consult instruction for use		Fragile
	Keep dry				

Registrant, Production enterprise name: Chengdu Besmile Biotechnology Co., Ltd.  
After sales service by: Chengdu Besmile Biotechnology Co., Ltd.